

SLOTTED TUBE

22mm SQUARE TUBE - STEEL SLOTTED 1 FACE 40mm PITCH

Code: **SG122** Single slot only
 Lengths: 2.4, 3.0 & 3.6m
 Colour: Raw
 Stock status: Made to order

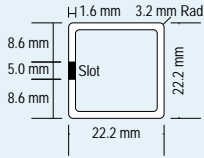

22mm SQUARE TUBE - STEEL SLOTTED 2 OPPOSITE FACES 40mm PITCH

Code: **SG122** Single slot only
 Lengths: 2.4, 3.0 & 3.6m
 Colour: Raw
 Stock status: Made to order

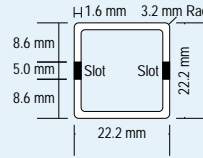

25mm SQUARE TUBE - STEEL SLOTTED 1 FACE 40mm PITCH

Code: **SG125** Single slot only
 Lengths: 2.4, 3.0 & 3.6m
 Colour: Raw
 Stock status: Ex-stock
 (Powder coat colours to order)

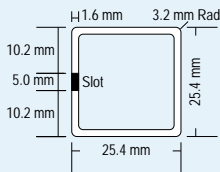

25mm SQUARE TUBE - STEEL SLOTTED 2 OPPOSITE FACES 40mm PITCH

Code: **SG125** Single slot only
 Lengths: 2.4, 3.0 & 3.6m
 Colour: Raw
 Stock status: Ex-stock
 (Powder coat colours to order)

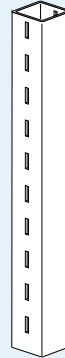
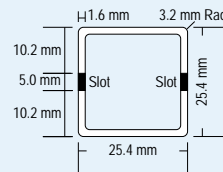

32mm SQUARE TUBE - STEEL SLOTTED 1 FACE 40mm PITCH

Code: **SG132** Single or Double slot
 Lengths: 2.4, 3.0 & 3.6m
 Colour: Raw
 Stock status: Ex-stock
 (Powder coat colours to order)

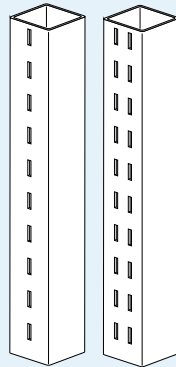
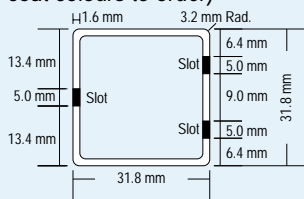

32mm SQUARE TUBE - STEEL SLOTTED 2 OPPOSITE FACES 40mm PITCH

Code: **SG132** Single or Double slot
 Lengths: 2.4, 3.0 & 3.6m
 Colour: Raw
 Stock status: Ex-stock
 (Powder coat colours to order)

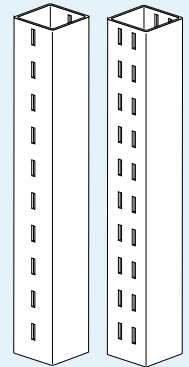
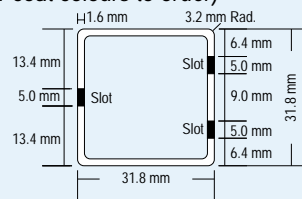

50 x 32mm TUBE - STEEL SLOTTED 1 FACE 40mm PITCH

Code: **SG150** Single or Double slot
 Lengths: 2.4, 3.0 & 3.6m
 Colour: Raw
 Stock status: Ex-stock
 (Powder coat colours to order)

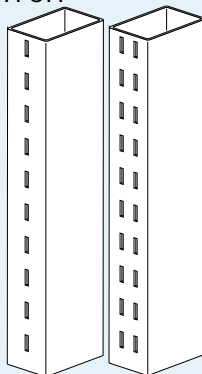
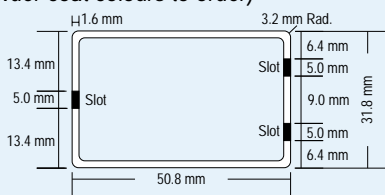

50 x 32mm TUBE - STEEL SLOTTED 2 OPPOSITE FACES 40mm PITCH

Code: **SG150** Single or Double slot
 Lengths: 2.4, 3.0 & 3.6m
 Colour: Raw
 Stock status: Ex-stock
 (Powder coat colours to order)

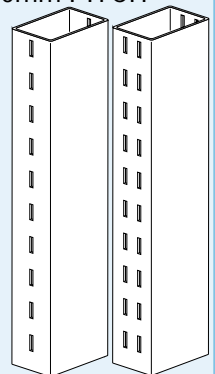
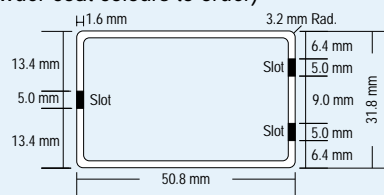

SLOTTED TUBE

CEILING CONNECTORS - ZINCSEAL FOR SLOTTED TUBE

Code: **SG12550** for 25mm Sq tube
Code: **SG13250** for 32mm Sq tube
Code: **SG15050** for 50 x 32mm tube
Colour: Zincseal
Stock status: Ex-stock

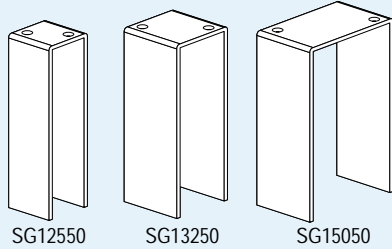

WALL CONNECTORS - STEEL FOR SLOTTED TUBE

Code: Special
Length: To suit
Colour: Chrome or Powder Coat
Stock status: Made to order

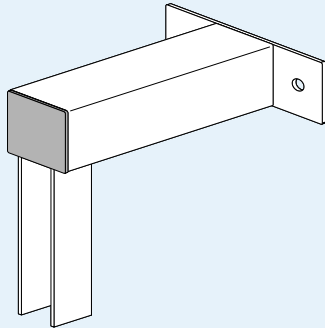

COVER SLEEVES - STEEL FOR SLOTTED TUBE

Code: **SG12560** for 25mm Sq tube
Code: **SG13260** for 32mm Sq tube
Code: **SG15060** for 50 x 32mm tube
Length: 100mm
Colour: Chrome
Stock status: Ex-stock

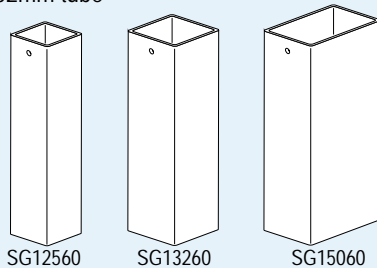

LEVELLING JACKS - STEEL FOR SLOTTED TUBE

Code: **SG12570** for 25mm Sq tube
Code: **SG13270** for 32mm Sq tube
Code: **SG15070** for 50 x 32mm tube
Colour: Zinc Plated
Stock status: Ex-stock

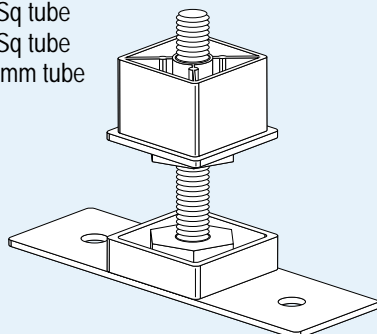

Tube insert included.

TYPICAL SLOTTED TUBE SET UP

The slotted tube system is well suited to open access window displays, island displays, partition style displays and as display dividers.

You can also use the slotted tube system for storerooms and backrooms.

IMPORTANT: It is imperative that the fixing points and the fixing hardware you choose are suitable for the application in which you intend to use the system.

Fixing Recommendations

1. Ensure all fixing points are strong enough to take the expected weight of the system.
2. Mark fixing point on ceiling or wall and floor at required centres.
3. Fix ceiling/wall connector into place.
4. Ensure tube is 40mm smaller (min.) than clear opening height.
5. Slide cover sleeve over tube and fit levelling jack into the end of the tube.
6. Locate the top of the tube over the ceiling/wall connector and adjust levelling jack to a suitable height. Do not fix yet.
7. Use a spirit level to check the vertical line of the tube.
8. Fix levelling jack to floor using appropriate fixing hardware.
9. Repeat the process for all posts checking the horizontal level of the slots as you go.

